

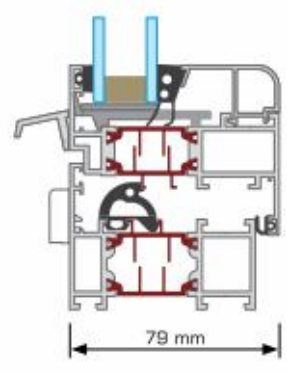

- $U_f$  from 1,0 W/m<sup>2</sup>K
- Flexibility of design
- Burglar resistance

Window and door system

# MB-70



Opening window - cross-section

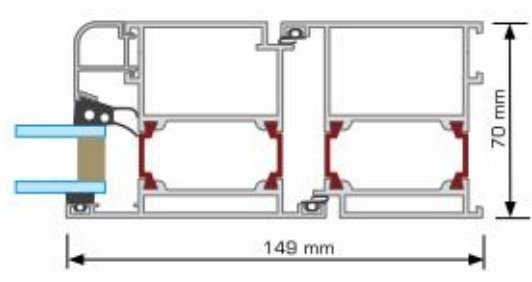

Door - cross-section

The Aluprof MB-70 is a high performance and fully integrated window and door system. Due to the specially designed polyamide break and extruded gaskets that are incorporated into the aluminum profile it offers excellent thermal insulation performance with the  $U_f$  rate from 1,0 W/m<sup>2</sup>K and reduced noise properties. The range perfectly suites with Aluprof's curtain walling and framing products and is appropriate for installation in low and high rise buildings for new buildings and refurbishment projects.



## MB-70

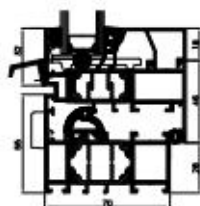

Opening window - cross-section

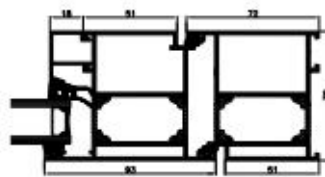

Door - cross-section



The base variety features special construction of thermal break and innovative 2-chamber gasket design.

## MB-70 HI

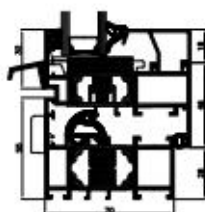

Opening window - cross-section



Door - cross-section



Enhanced thermal insulation variety offers excellent thermal performance with the  $U_f$  from  $1,0 \text{ W/m}^2\text{K}$  due to uniquely designed insulating inserts incorporated inside aluminum profile and in glazing areas.

## MB-70US / MB-70US HI

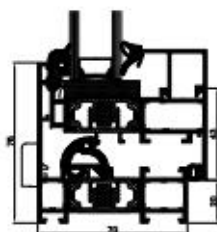

Opening window - cross-section

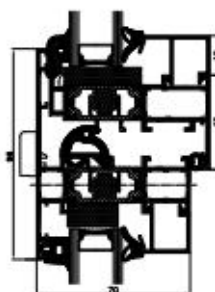

Opening window and fixed window - cross-section



The invisible window sash variety. It enables an effect of indifferent look of series of neighboring combination of fixed and opening windows from the outside of the building. It gives an impression of light and neat look since low width of frames seen from the outside. Available in both regular and HI variety with enhanced thermal insulation.

## MB-70 INDUSTRIAL / MB-70 INDUSTRIAL HI

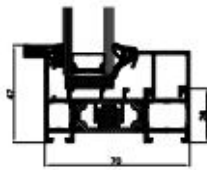

Fixed window - cross-section

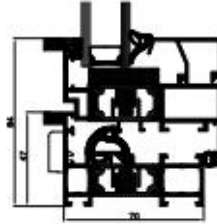

Opening window - cross-section



Whether for renovating old steel windows or giving a stylish steel look to new-build, the MB-70 Industrial enables to keep with the original style, providing all the benefits of modern aluminum technology. Combining attractive design options with long term reliability, the system also features enhanced thermal insulation properties to ensure energy conservation.

## MB-70SG

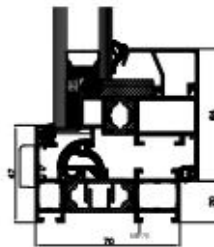

Opening window  
- cross-section

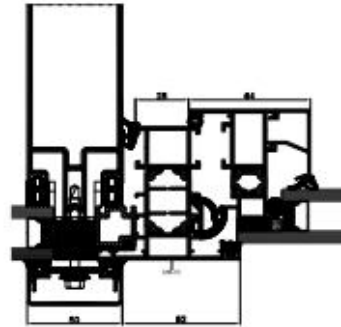

Active window in a curtain wall  
- cross-section



The variety of system that enables to make window with sash invisible from the outer space. It resembles regular concealed sash construction but since its frame features 47 mm width it is therefore narrower than MB-70US and offers slimmer and lighter look.

## MB-70CW / MB-70CW HI

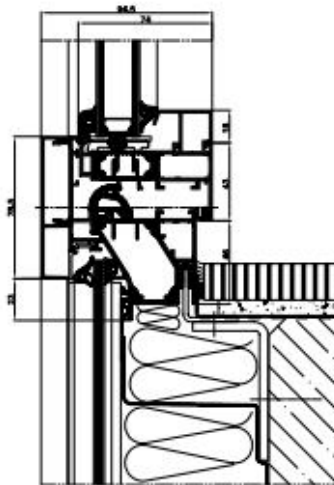

Cross-section of an active window



The variety of window that applies where there is curtain walls made up from either reinforced concrete or masonry. It features warm and cold zones with combination of high thermal insulation and in between window strips. Helps reduce fabricating and assembly time. Available in regular and enhanced thermal insulation versions.

## FEATURES AND BENEFITS

- windows available as fixed or open in, tilt and turn, tilt and slide
- 1 or 2 leaf doors open in or open out
- safety locking
- steel look like industrial options
- large size door constructions available
- hidden sash option
- secure windows and door options, providing burglar resistance
- multitude of finish options
- dual color options
- glazing up to 60 mm
- multi-point locking
- Eurogroove that broadens the choice of hardware available
- suites with other Aluprof's MB systems allowing total design flexibility and project solutions
- compliance with CE marking requirements

TECHNICAL SPECIFICATION	MB-70 MB-70 HI	MB-70US MB-70US HI	MB-70 Industrial MB-70 Industrial HI	MB-70SG	MB-70CW MB-70CW HI
Depth of Frame (door / window)	70 / 70				
Depth of Leaf (door / window)	70 / 79				
Glazing range mm (fixed window and door / opening window)	15 - 51 / 23 - 60	9 - 45 / 18 - 54	21-57	18 - 54	9 - 45 / 18 - 54
<b>Min visible width T profile</b>					
Door / window frame	51 / 47	75	47	47	78,5
Door / window leaf	72 / 32	-	32	-	34,6
<b>Size and weight limitations</b>					
Maximum size of window (HxW)	H 2400 mm W 1250 mm	H 1900 mm W 2400 mm	-	H 2400 mm W 2000 mm	-
Maximum size of door (HxW)	H 2400 mm W 1300 mm	-	-	-	-
Max weight of doors / windows	120 / 130 kg	130 kg	-	130 kg	-
<b>Types of construction</b>					
	tilt window, turn window, tilt&turn window, doors open in and open out	fixed window, tilt window, turn window, tilt&turn window	fixed window, tilt&turn window	turn window, tilt window, tilt&turn window	fixed window, tilt&turn window

PERFORMANCE	MB-70	MB-70 HI	MB-70US	MB-70US HI	MB-70 Industrial MB-70 Industrial HI	MB-70SG	MB-70CW MB-70CW HI
Air Permeability	Class 4, EN 1026:2001; EN 12207:2001						
Resistance to windload	Class C5 (2000Pa) EN 12211:2001; EN 12210:2001					Class C6 (>2000Pa) EN 12211:2001; EN 12210:2001	Class C5 (2000Pa) EN 12211:2001; EN 12210:2001
Watertightness	Class E1050 (1050Pa) EN 1027:2001; EN 12208:2001		Class E1200 (1200Pa) EN 1027:2001; EN 12208:2001		Class E1050 (1050Pa), EN 1027:2001; EN 12208:2001		E750 (750Pa) EN 1027:2001; EN 12208:2001
Thermal Insulation $U_f$ (W/m <sup>2</sup> K)	from 1,5	from 1,0	from 1,5	from 1,5	from 1,9	from 2,2	from 1,4



**DAFAS Sp. z o.o. Sp. k.**  
 Batowice 92  
 32-086 Węgrzce  
 Poland

**e-mail: [biuro@dafas.eu](mailto:biuro@dafas.eu)**  
**tel: +48 507 026 523**